



Character VFD Module
Y-Series
Easy Starter Guide
(Control VFD Module from PC)

DOCUMENT NO. :E-M-0002-00

DATE OF ISSUE : Jan. 29, 2009

REVISION : Jan. 29, 2009

Noritake Co., Inc.
2635 Clearbrook Drive Arlington Height, IL 60005
www.noritake-elec.com

The *itron*[®] is the registered trademark of Noritake Itron Corp.
This document is subject to change without notice.

1	Getting Started	3
1.1	Introduction.....	3
1.2	Features of Y-Series VFD Module	3
1.3	Precautions	3
2	Connecting to PC	4
2.1	Hardware Connection for CUXXXXX-Y1A Model.....	4
2.2	Hardware Connection for CUXXXXX-Y100 Model	4
2.3	Connecting Hardware.....	5
2.4	Accessories.....	5
2.5	GUD-10k Software.....	6
2.5.1	Installing and Executing Software	6
2.5.2	Communication Setup.....	8
2.5.3	Controlling VFD Module.....	8
2.5.4	Writing and Executing Command Set.....	9
2.5.5	Copying and Executing Sample Command Set.....	9
3	Sample Command Sets	11
3.1	Displaying Characters.....	11
3.2	Blinking Characters.....	11
3.3	Underlining Characters	12
3.4	Highlighting Characters	12
3.5	User-Definable Font – RAM.....	13
3.6	User-Definable Font – Flash ROM	14
3.7	Alternative Magnified Font.....	15
3.8	Alternative 5×7 Font	15
3.9	Displaying Symbols (Character Code Type)	16
3.10	Displaying Symbols (International Font Set).....	16
3.11	Displaying Firmware Version.....	17
3.12	Power Save Mode	17
4	Optical Color Filters	18
5	Revision History	19

1 Getting Started

1.1 Introduction

This easy starter guide gives you step-by-step instructions to control the CU24043-Y1A Y-Series Vacuum Florescent Display module (Fig. 1-1) from a PC.

Since all the Y-Series VFD modules share the same features and command sets, the starter guide is able to apply to any Y-Series VFD module with/without minor hardware/software modifications. For further technical inquiries and the latest Y-Series lineup information, please contact your local sales representative or visit our website at www.noritake-elec.com/Y-series.htm.



Fig. 1-1

Product image, including color, may differ from actual product appearance.

1.2 Features of Y-Series VFD Module

The Y-Series is a 5×8 matrix character VFD module designed to reduce development cost and time. The module requires only a single 5VDC power supply and works with virtually any host system as long as one of the following interfaces is available:

- 8-bit parallel 5VDC CMOS Level (CUXXXXX-Y1A model and CUXXXXX-Y100 model)
- Synchronous serial 5VDC CMOS Level (CUXXXXX-Y1A model)
- Asynchronous serial 5VDC CMOS Level (CUXXXXX-Y1A model)
- Asynchronous serial RS232 Level (CUXXXXX-Y100 model)

With simple hex-code command sets, the module provides various functions such as highlighting characters, blinking characters, underling characters, font magnification, etc. which conventional character displays do not have. Additionally, various fonts including basic ASCII font, international font, symbols and user-definable font can be easily displayed.

1.3 Precautions

A VFD module is a precision and fragile instrument, so it is necessary to handle it with scrupulous care. Some main points of handling it are as follows:

- Because the edges of a VFD glass-envelop are not smooth, it is necessary to handle carefully to avoid injuries to your hands.
- Avoid touching conductive electrical parts, because a VFD module uses high voltage exceeding 30 ~ 50 volts.
- Do not unplug the power and/or data cables of a VFD module during operating condition because unrecoverable damage may result.
- A VFD module needs electrostatic free packaging and protection from electrostatic charges during handling and usage.

Before open the package, please refer to your specific module specification “Notice for the Cautious Handling VFD Modules”.

2 Connecting to PC

The VFD module is able to connect with a PC via asynchronous serial interface and can be controlled from the PC. This reduces the cost and time of development. The asynchronous mode is the default setting, so changing jumper setting is not required to use this mode. One of the four baud rates (9600 bps, 19,200 bps, 38,400 bps or 115,200 bps) is selectable with Jumper 0 and 1. The default baud rate is 38,400 bps. Refer to your specific module specification “Serial Interface” and “Jumper Setting”.

2.1 Hardware Connection for CUXXXXX-Y1A Model

The Y-Series CUXXXXX-Y1A model does not have a built-in RS232 chip, so the NTC-04-0009 serial cable having the chip is required. In order to connect the module to a PC, the NTC-04-0009 serial cable (optional), the NTC-05-0006 AC110V/DC5V power adapter (optional) and the GUD-10k Graphical User Interface software (downloadable from Noritake website) are required.

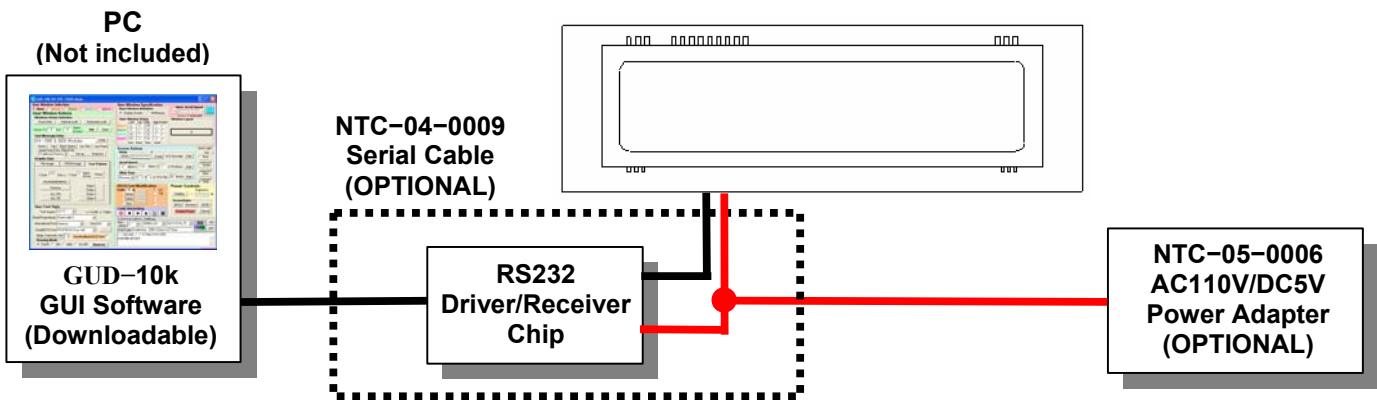

Fig. 2-1

2.2 Hardware Connection for CUXXXXX-Y100 Model

The Y-Series CUXXXXX-Y100 model has a built-in RS232 chip, so the NTC-04-0004 serial cable is required. In order to connect the module to a PC, the NTC-04-0004 serial cable (optional), the NTC-05-0006 AC110V/DC5V power adapter (optional) and the GUD-10k Graphical User Interface software (downloadable from Noritake website) are required.

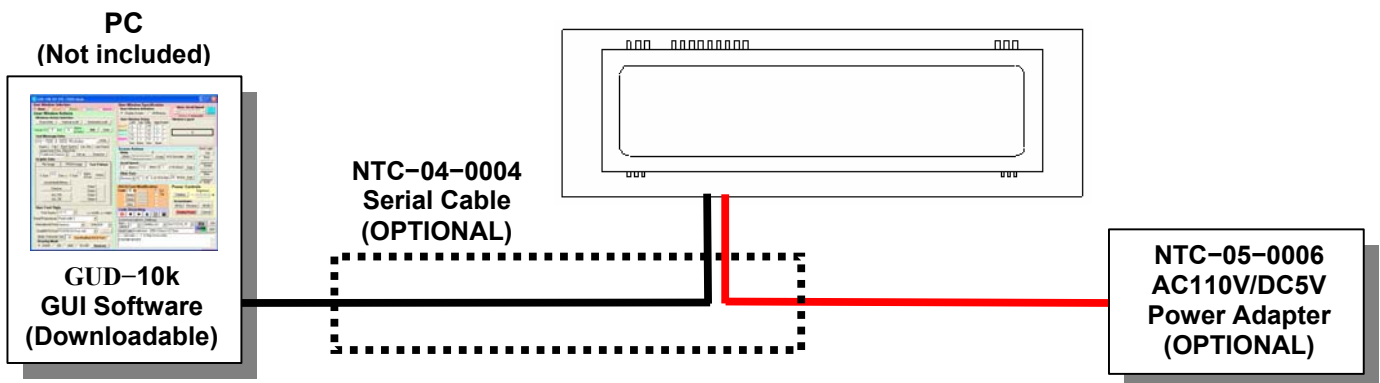

Fig. 2-2

2.3 Connecting Hardware

In order to connect the CU24043-Y1A module to a PC, please refer to the following steps:

1. Plug the NTC-04-0009 into an available RS232 serial port of a PC (Fig. 2-3). If your PC does not have serial ports, a USB to RS232 converter is required.
2. Connect the 6-pin connector to the header (optional) of the VFD module (Fig. 2-4). Fig. 2-4 shows the pin configuration of the CU24043-Y1A. Refer to your specific module specification “Pin Configuration” before connecting.
3. Connect the plug of NTC-05-0006 to the receptacle of the serial cable (Fig. 2-3).
4. Connect the power adapter to 110VAC power source.

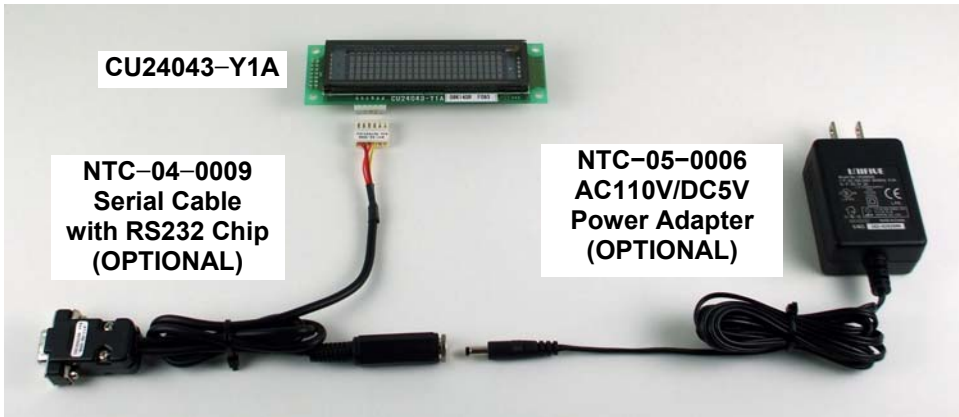

Fig. 2-3

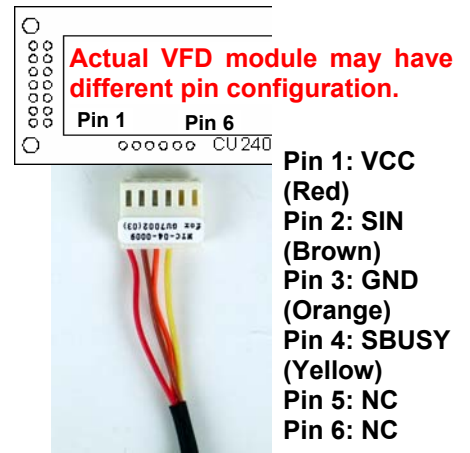

Fig. 2-4

Note: Noritake provides the NTC-04-0009, the NTC-05-0006 and headers (refer to section 2.4). For further information, please contact your local sales representative.

2.4 Accessories

Noritake provides these serial interface accessories. For further information, please contact your local sales representative.



Fig. 2-5: 6-Wire Cable



Fig. 2-6:
 6-Pin
 Straight
 Header
 W/Lock

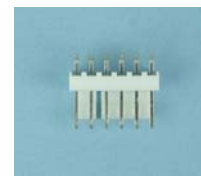

Fig. 2-7:
 6-Pin
 Right-Angle
 Header
 W/Lock

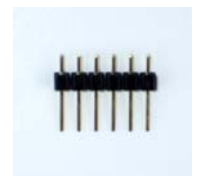



Fig. 2-8:
 6-Pin
 Header

2.5 GUD-10k Software

The GUD-10k is graphical user interface software originally designed for the GU-3000 and GU-7000 series graphic VFD modules. It is also capable of controlling the Y-Series character module, but some functions of GUD-10k do not work for the Y-Series. The GUD-10k is able to run on Windows XP and VISTA.

2.5.1 Installing and Executing Software

In order to install and execute the software, please refer to the following steps:

1. Go to our website for development kits: www.noritake-elec.com/3000_development_kit.htm.
2. Read the terms to download free of charge (Fig. 2-9).
3. If you agree the terms, mark the box "YES, I AGREE." (Fig. 2-9).
4. Click "Download Software" (Fig. 2-9).
5. Click "Open" (Fig. 2-10).
6. Double Click "GUD10kXXXX.exe" (Fig. 2-11).
7. Click "OK" (Fig. 2-12).
8. Click  to install the software (Fig. 2-13).
9. Click "Continue" (Fig. 2-14).
10. Go to "start" → "Programs" → "Noritake VFD" → "GUD10k" to execute the software.
11. Go to "start" → "Programs" → "Noritake VFD" → "GUD10k Manual" to read the manual.

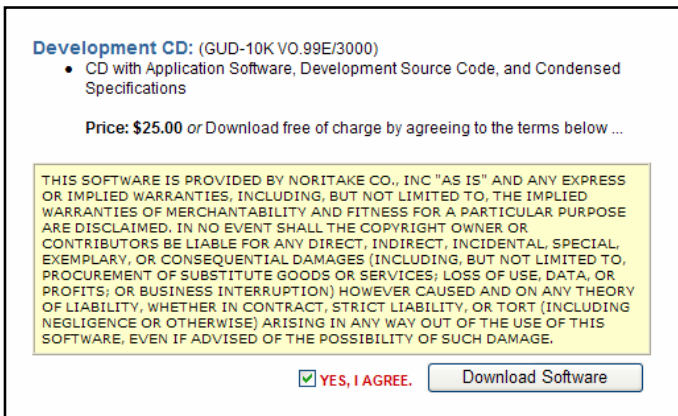

Fig. 2-9

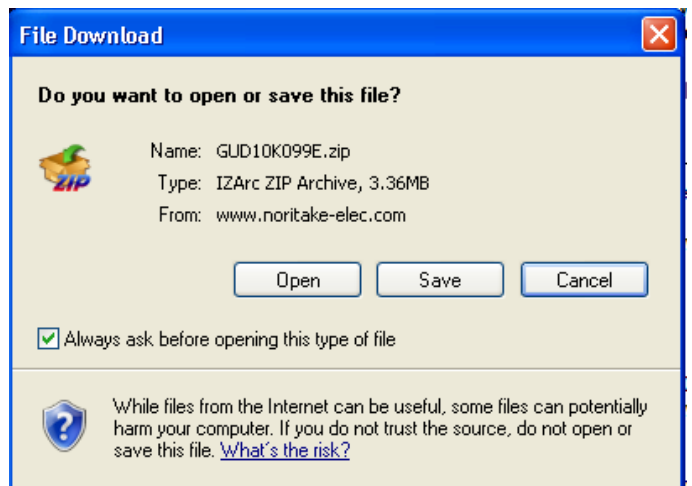

Fig. 2-10

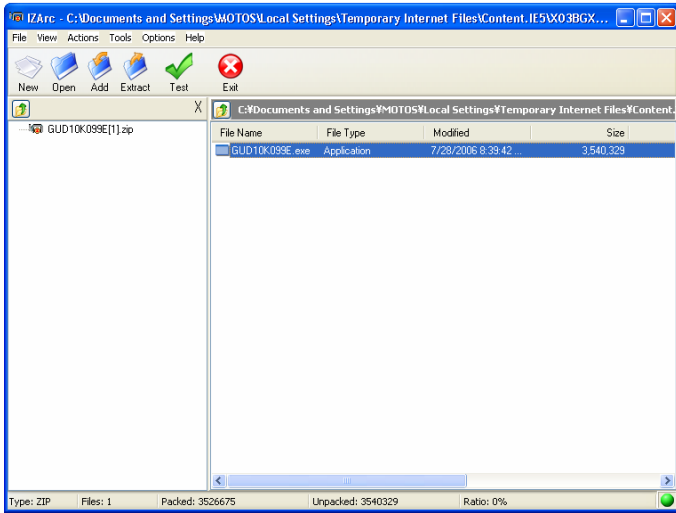

Fig. 2-11



Fig. 2-12

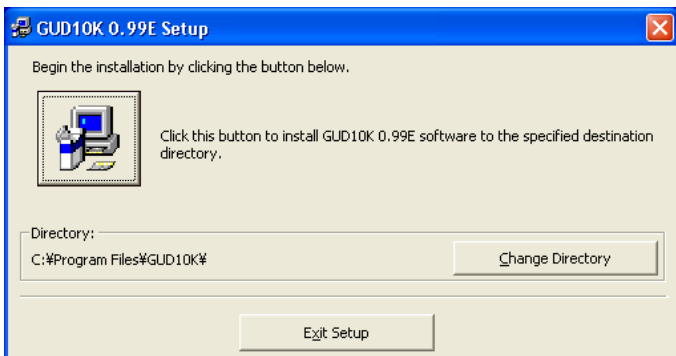

Fig. 2-13

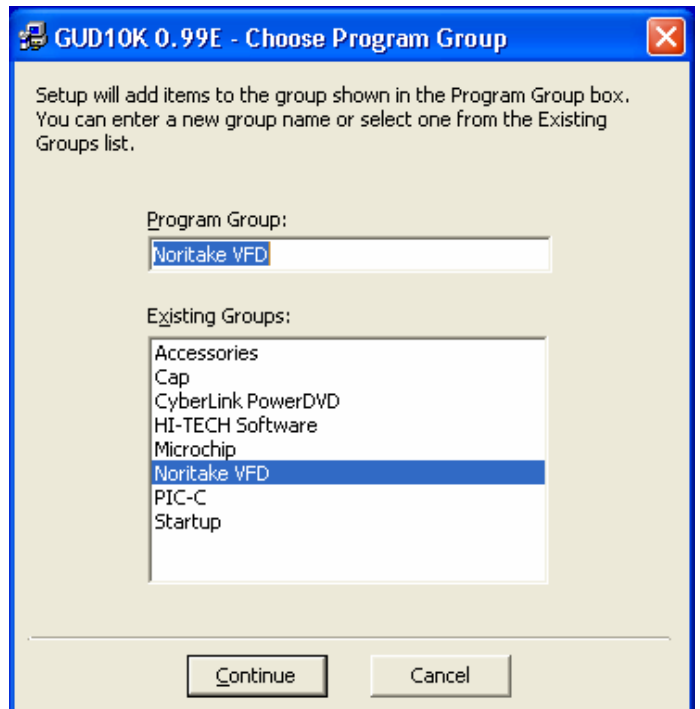

Fig. 2-14

2.5.2 Communication Setup

In order to connect the module to a PC, please refer to buttons and text boxes bordered in red (Fig. 2-15) and the following steps:

1. Select the port which the display is connected into (“Search” button shows a list of used/unused ports).
2. Select one of the four baud rates (9,600 bps, 19,200 bps, 38,400 bps or 115,200 bps). The baud rate is selected by jumper setting, and its default value is 38,400 bps. Please refer to your specific module specification “Serial Interface” and “Jumper Setting”.
3. Click **ON** button to be online.

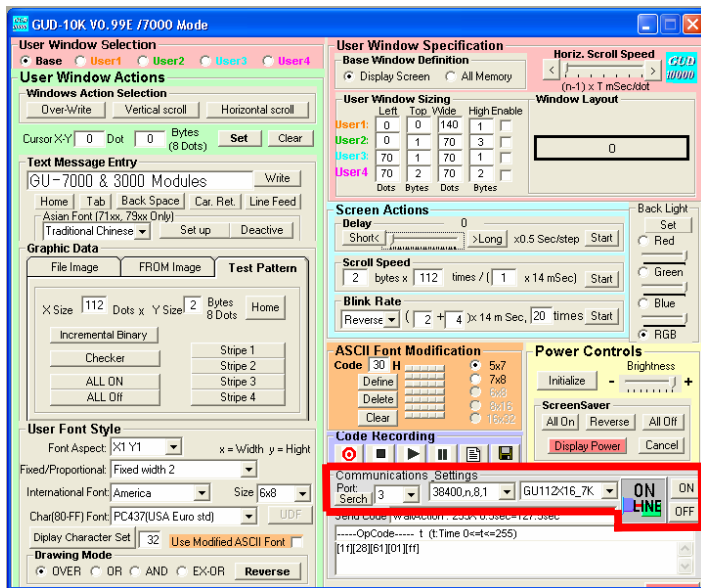

Fig. 2-15

Note: **GU112x16_7K** is for selecting a type of graphic module (GU-3000 or 7000 Series). Selecting any graphic module does not affect the connected Y-Series module.

2.5.3 Controlling VFD Module

In Fig. 2-16, only the graphical buttons and text boxes bordered in red work for the CU24043-Y1A. Using the other buttons and functions may cause errors to the module.

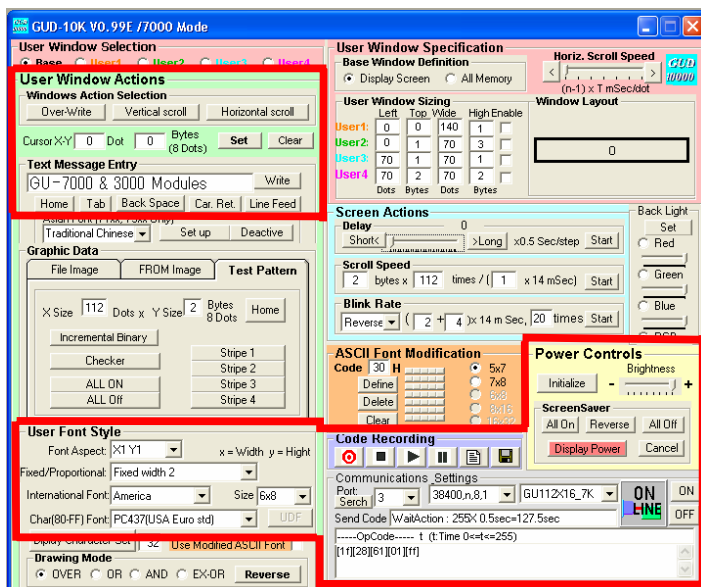

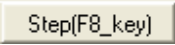

Fig. 2-16

Note: **GU112x16_7K** is for selecting a type of graphic module (GU-3000 or 7000 Series). Selecting any graphic module does not affect the connected Y-Series module.

2.5.4 Writing and Executing Command Set

In order to execute functions of the module, combining several commands is required in most cases. GUD-10k has a special window to write and execute a command set. Please refer to Fig. 2-17, Fig. 2-18 and the following steps:

1. Click  button to open a command set edit window (Fig. 2-17).
2. Write hex-code commands. Each command has to begin with “PRT” and end with ‘;’ (Fig. 2-18).
3. Click  button to execute all the commands at once (Fig. 2-18).
4. Click  button to execute each command step by step (Fig. 2-18).

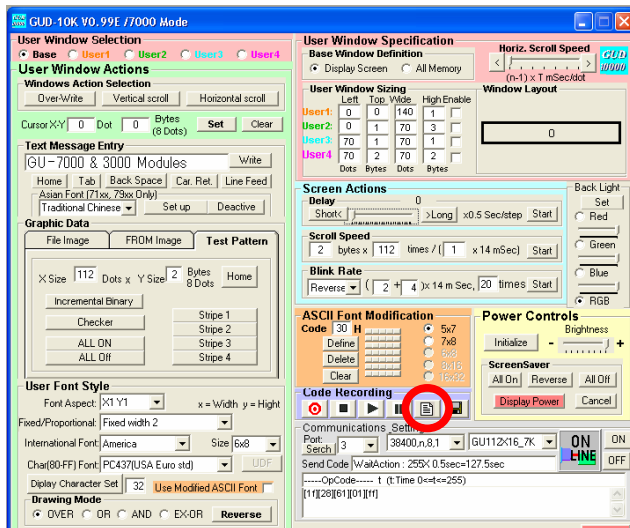

Fig. 2-17

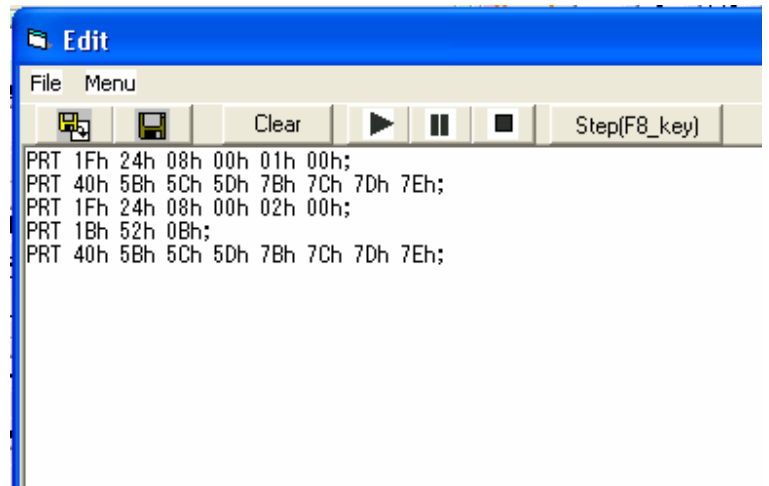

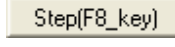

Fig. 2-18

2.5.5 Copying and Executing Sample Command Set

In section 3, some sample command sets are provided. In order to copy and execute the sample codes, please refer to Fig. 2-19, Fig. 2-20, Fig. 2-21 and the following instructions:

1. Copy a hex-code sample command set (Fig. 2-19).
2. Click  button to open a command set edit window (Fig. 2-17).
3. Paste the sample command set into the window (Fig. 2-20).
4. Add “PRT” and ‘;’ to each command (Fig. 2-21).
5. Click  button to execute all the commands at once (Fig. 2-21).
6. Click  button to execute each command step by step (Fig. 2-21).

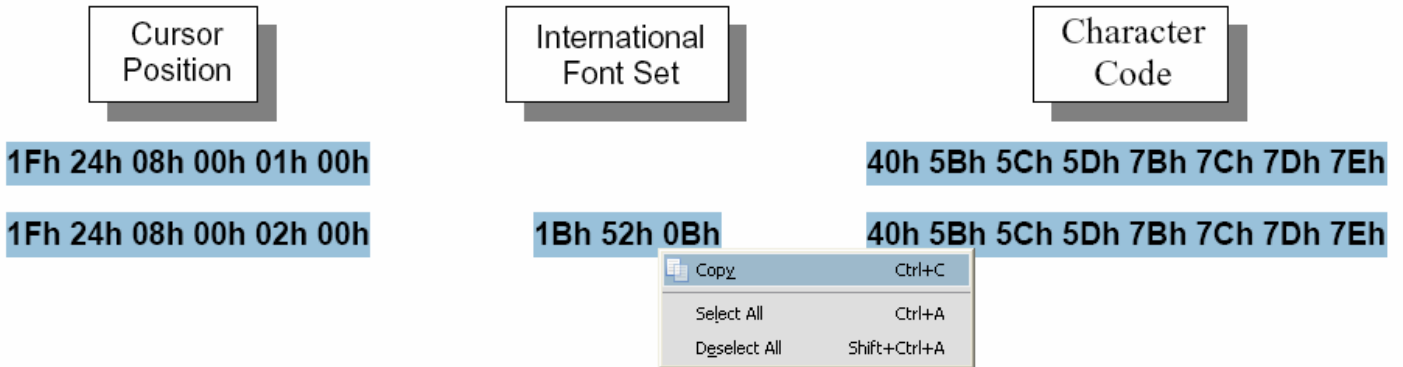

Fig. 2-19

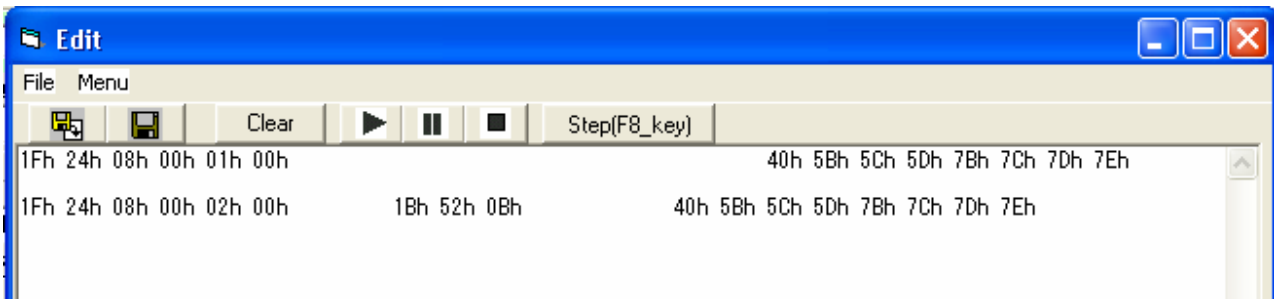

Fig. 2-20

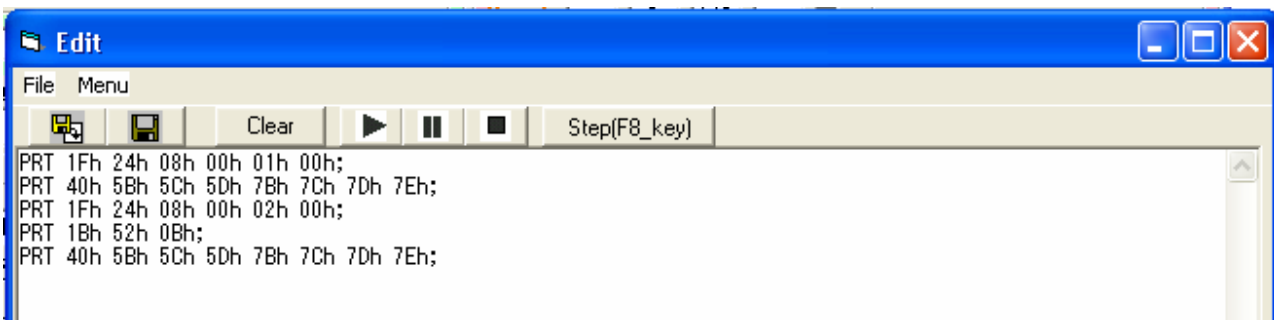

Fig. 2-21

3 Sample Command Sets

3.1 Displaying Characters

The VFD module contains three font sizes: a 1×1 regular font size (5×8 pixel), a 1×2 magnified font size (5×16 pixel) and a 2×2 magnified font size (10×16 pixel). A character is displayed at the current cursor position, and the position is set by using 'Cursor set' command. The cursor position is incremented after each character is displayed. Refer to your specific module specification "Display Area-End of Line Behavior". The following command set displays characters shown in Fig. 3-1.

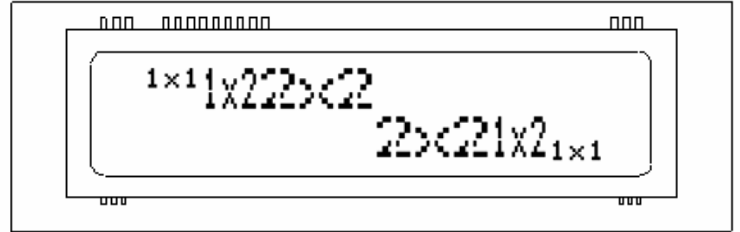

Fig. 3-1

Cursor Position	Character Size	Character Code
		31h 78h 31h
	1Fh 28h 67h 40h 01h 02h	31h 78h 32h
	1Fh 28h 67h 40h 02h 02h	32h 78h 32h
1Fh 24h 0Ch 00h 02h 00h	1Fh 28h 67h 40h 02h 02h	32h 78h 32h
	1Fh 28h 67h 40h 01h 02h	31h 78h 32h
1Fh 24h 15h 00h 03h 00h	1Fh 28h 67h 40h 01h 01h	31h 78h 31h

3.2 Blinking Characters

The VFD module features an individual matrix (character) blinking function. The following command set displays characters shown in Fig. 3-2.

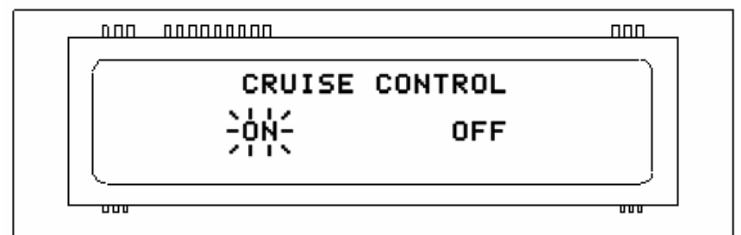

Fig. 3-2

Cursor Position	Blink Character	Character Code
1Fh 24h 05h 00h 00h 00h		43h 52h 55h 49h 53h 45h 20h 43h 4fh 4Eh 54h 52h 4fh 4Ch
1Fh 24h 05h 00h 02h 00h	1Bh 42h	4Fh 4Eh
1Fh 24h 10h 00h 02h 00h	1Bh 41h	4Fh 46h 46h

3.3 Underlining Characters

The VFD module features an individual matrix (character) underlining function. The following command set displays characters shown in Fig. 3-3.

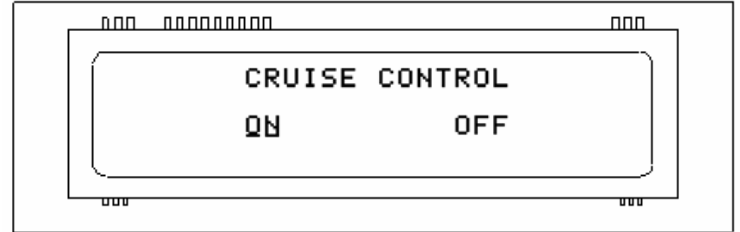

Fig. 3-3

Cursor
Position

Underline
Character

Character
Code

1Fh 24h 05h 00h 00h 00h

43h 52h 55h 49h 53h 45h 20h 43h 4fh 4Eh 54h 52h 4fh 4Ch

1Fh 24h 05h 00h 02h 00h 1Bh 55h

4Fh 4Eh

1Fh 24h 10h 00h 02h 00h 1Bh 57h

4Fh 46h 46h

3.4 Highlighting Characters

The VFD module features the individual character brightness control function. Individual character brightness is a relative value of over all display brightness. In order to make highlighted characters conspicuous, higher over all display brightness and lower non-highlighted character brightness are recommended. The following command set displays characters shown in Fig. 3-4.

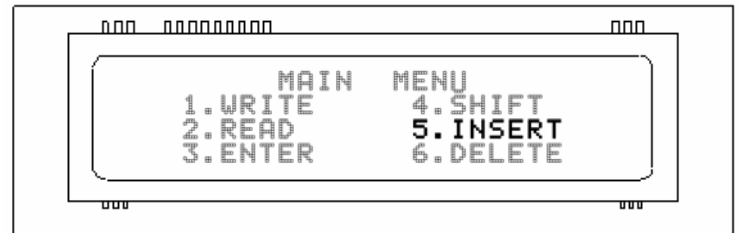

Fig. 3-4

Display
Brightness

Cursor
Position

Character
Brightness

Character
Code

1Fh 58h 08h 1Fh 24h 07h 00h 00h 00h

1Fh 28h 67h 50h 03h 00h 00h

4Dh 41h 49h 4Eh

1Fh 24h 0Dh 00h 00h 00h

4Dh 45h 4Eh 55h

1Fh 24h 02h 00h 01h 00h

31h 2Eh 57h 52h 49h 54h 45h

1Fh 24h 0Eh 00h 01h 00h

34h 2Eh 53h 48h 49h 46h 54h

1Fh 24h 02h 00h 02h 00h

32h 2Eh 52h 45h 41h 44h

1Fh 24h 0Eh 00h 02h 00h

1Fh 28h 67h 50h 08h 00h 00h

35h 2Eh 49h 4Eh 53h 45h 52h 54h

1Fh 24h 02h 00h 03h 00h

1Fh 28h 67h 50h 03h 00h 00h

33h 2Eh 45h 4Eh 54h 45h 52h

1Fh 24h 0Eh 00h 03h 00h

36h 2Eh 44h 45h 4Ch 45h 54h 45h

3.5 User-Definable Font – RAM

User-definable font – RAM is stored (maximum 16 characters) and displayed in a horizontal orientation. A user-definable font can be stored into RAM location 20h to FFh. The first command set defines two symbols (Fig. 3-6 and Fig. 3-7), and the second set displays the symbols and some characters (Fig. 3-5). An initialization of the module clears all defined RAM user fonts.

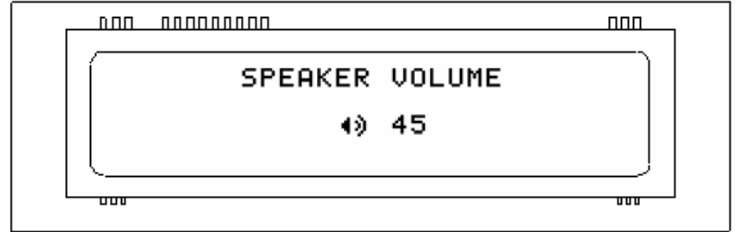

Fig. 3-5

DEFINING FONTS (Fig. 3-6 and Fig. 3-7)

Define RAM User Font	Starting Character Code	Ending Character Code	The number of bytes for a character	BYTE 1 DATA	BYTE 2 DATA	BYTE 3 DATA	BYTE 4 DATA	BYTE 5 DATA
1Bh 26h 01h	50h	51h	05h	00h	62h	CEh	31h	04h
			05h	82h	24h	A5h	12h	11h

DISPLAYING CHARACTERS (Fig. 3-5)

Enable RAM User Font	Cursor Position	Character Code
1Bh 25h 01h	1Fh 24h 05h 00h 00h 00h	53h 50h 45h 41h 4Bh 45h 52h 20h 56h 4Fh 4Ch 55h 4Dh 45h
1Bh 25h 00h	1Fh 24h 0Ah 00h 02h 00h	50h 51h
	1Fh 24h 0Dh 00h 02h 00h	34h 35h

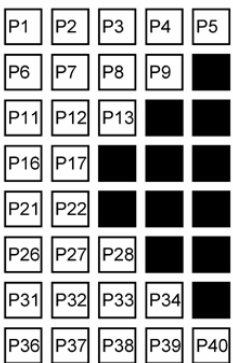

Fig. 3-6

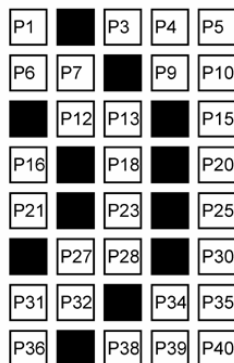

Fig. 3-7

Each bit value is logic level one, in Fig. 3-6, Fig. 3-7 and Table 3-1, if a pixel is ON, whereas the value is logic level zero if a pixel is OFF. The character code address location of Fig. 3-6 and Fig. 3-7 are 50h and 51h respectively in this example.

	B7 (MSB)	B6	B5	B4	B3	B2	B1	B0 (LSB)
BYTE 1	P8	P7	P6	P5	P4	P3	P2	P1
BYTE 2	P16	P15	P14	P13	P12	P11	P10	P9
BYTE 3	P24	P23	P22	P21	P20	P19	P18	P17
BYTE 4	P32	P31	P30	P29	P28	P27	P26	P25
BYTE 5	P40	P39	P38	P37	P36	P35	P34	P33

Table 3-1

3.6 User-Definable Font – Flash ROM

User-definable font – Flash ROM is stored (224 characters: 20h ~ FFh) and displayed in a horizontal orientation. All 224 character data has to be defined at once, so dummy blank data is stored in the unused memory space. The first command set defines two symbols (Fig. 3-9 and Fig. 3-10), and the second set displays the symbols and some characters (Fig. 3-8). An initialization of the module does not clear defined ROM user fonts.

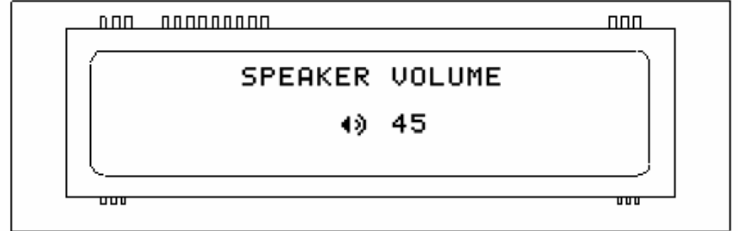

Fig. 3-8

DEFINING FONTS (Fig. 3-9 and Fig. 3-10)

User Setup Mode	Define ROM User Font	BYTE 1 DATA	BYTE 2 DATA	BYTE 3 DATA	BYTE 4 DATA	BYTE 5 DATA
1Fh 28h 65h 01h 49h 4Eh	1Fh 28h 65h 14h	00h	62h	CEh	31h	04h
		82h	24h	A5h	12h	11h
		00h	00h	00h	00h	00h
Input '00h' as dummy blank data up to FFh.						
		00h	00h	00h	00h	00h
1Fh 28h 65h 02h 4Fh 55h 54h						

DISPLAYING CHARACTERS (Fig. 3-8)

Select Font Type	Cursor Position	Character Code
1Fh 24h 05h 00h 00h 00h	53h 50h 45h 41h 4Bh 45h 52h 20h 56h 4Fh 4Ch 55h 4Dh 45h	
1Bh 74h FFh	1Fh 24h 0Ah 00h 02h 00h	20h 21h
1Bh 74h 00h	1Fh 24h 0Dh 00h 02h 00h	34h 35h

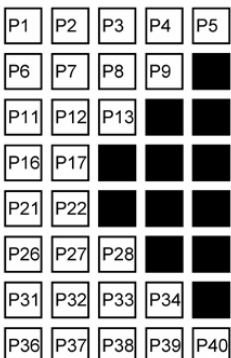

Fig. 3-9

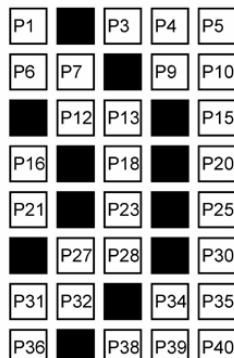

Fig. 3-10

Each bit value is logic level one, in Fig. 3-9, Fig. 3-10 and Table 3-1, if a pixel is ON, whereas the value is logic level zero if a pixel is OFF. The character code address location of Fig. 3-9 and Fig. 3-10 are 20h and 21h respectively in this example.

	B7 (MSB)	B6	B5	B4	B3	B2	B1	B0 (LSB)
BYTE 1	P8	P7	P6	P5	P4	P3	P2	P1
BYTE 2	P16	P15	P14	P13	P12	P11	P10	P9
BYTE 3	P24	P23	P22	P21	P20	P19	P18	P17
BYTE 4	P32	P31	P30	P29	P28	P27	P26	P25
BYTE 5	P40	P39	P38	P37	P36	P35	P34	P33

Table 3-2

3.7 Alternative Magnified Font

Only under 2×2 Font Magnification mode, 28 characters such as ‘!’, ‘1’, ‘(’, etc. can also be displayed in Alternative Magnified font instead of Common font. Refer to your specific module specification “Select/Deselect Alternative Magnified Font” and Font Specification DS-1519-0002 “Alternative Magnified Font”.

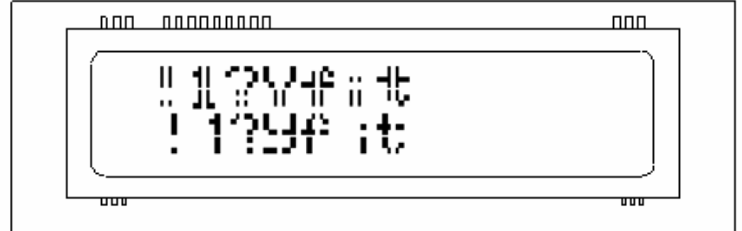

Fig. 3-11

Cursor
Position

Character
Size

Alternative
Font

Character
Code

1Fh 28h 67h 40h 02h 02h

21h 31h 3Fh 59h 66h 69h 74h

1Fh 24h 00h 00h 02h 00h

1Fh 28h 67h 06h 01h

21h 31h 3Fh 59h 66h 69h 74h

1Fh 28h 67h 06h 00h

3.8 Alternative 5×7 Font

These five characters ‘g’, ‘j’, ‘p’, ‘q’ and ‘y’ can also be displayed in Alternative 5×7 Matrix font instead of Common font. Refer to your specific module specification “Select/Deselect 5×8 Matrix Font” and Font Specification DS-1519-0002 “Alternative 5×7 Matrix Font”.

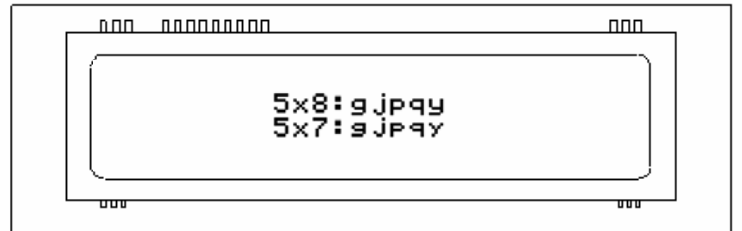

Fig. 3-12

Cursor
Position

Alternative
Font

Character
Code

1Fh 24h 07h 00h 01h 00h

35h 78h 38h 3Ah 67h 6Ah 70h 71h 79h

1Fh 24h 07h 00h 02h 00h

1Fh 28h 67h 04h 80h

35h 78h 37h 3Ah 67h 6Ah 70h 71h 79h

1Fh 28h 67h 04h 81h

3.9 Displaying Symbols (Character Code Type)

One of the 10 character code types is selectable, and its symbols and characters are added to Common font set. Refer to your specific module specification "Specify character code type" and Font Specification DS-1519-0002 "Character Code Type".

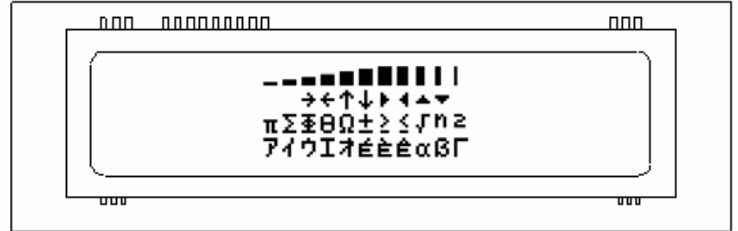

Fig. 3-13

Cursor
Position

- 1Fh 24h 06h 00h 00h 00h
- 1Fh 24h 08h 00h 01h 00h
- 1Fh 24h 06h 00h 02h 00h
- 1Fh 24h 06h 00h 03h 00h

Character
Code Type

- 1Bh 74h 01h
- 1Bh 74h 03h
- 1Bh 74h 01h
- 1Bh 74h 04h

Character
Code

- 80h 81h 82h 83h 84h 85h 94h 8Fh 8Eh 8Dh 8Ch
- 97h 98h 99h 9Ah E8h E9h EAh EBh
- E3h E4h E8h E9h EAh F1h F2h F3h FBh FCh FDh
- B1h B2h B3h B4h B5h
- 90h 91h 92h E0h E1h E2h

3.10 Displaying Symbols (International Font Set)

One of the 14 international font sets is selectable, and its symbols and characters replaces the corresponding code characters in Common font set. Refer to your specific module specification "Specify International font set" and Font Specification DS-1519-0002 "International Font Set".

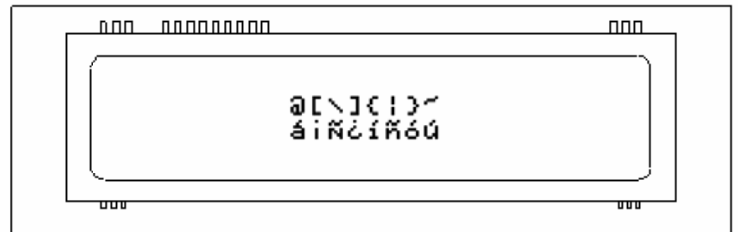

Fig. 3-14

Cursor
Position

- 1Fh 24h 08h 00h 01h 00h
- 1Fh 24h 08h 00h 02h 00h

International
Font Set

- 1Bh 52h 0Bh

Character
Code

- 40h 5Bh 5Ch 5Dh 7Bh 7Ch 7Dh 7Eh
- 40h 5Bh 5Ch 5Dh 7Bh 7Ch 7Dh 7Eh

3.11 Displaying Firmware Version

A version number of installed firmware can be displayed by the following command set.

User Setup
Mode

Display Firmware
Version

1Fh 28h 65h 01h 49h 4Eh

1Fh 28h 65h 14h

1Fh 28h 65h 02h 4Fh 55h 54h

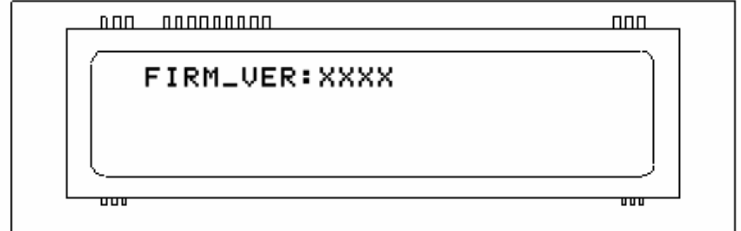

Fig. 3-15

3.12 Power Save Mode

Even though the module does not display anything, standby power still exists. Power Save Mode minimizes the standby power. The mode is cancelled when the next command is received.

Screen
Saver

1Fh 28h 61h 40h 00h

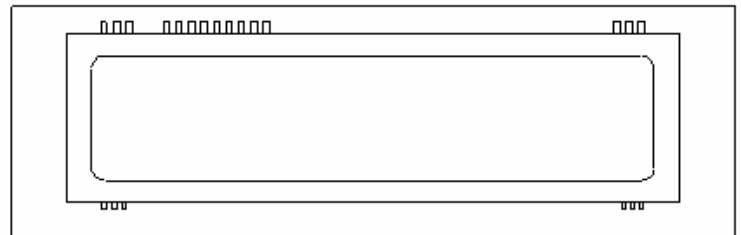

Fig. 3-16

4 Optical Color Filters

The original color of illumination is blue-green (Fig. 4-1), and it has a wide range of the color spectrum. Therefore, the color can be changed with optional color filters easily (Fig. 4-2 and 4-3). Noritake provides optional color filters. For further information, please contact your local sales representative or visit our website at www.noritake-elec.com/colors.htm.



Fig. 4-1 (No Filter)



Fig. 4-2 (With Green Filter)



Fig. 4-3 (With Blue Filter)

Product images, including color, may differ from actual product appearance.

5 Revision History

Version	Date	Revision Description	Prepared	Approved
00	01/29/09	Initial Issued	M. S.	A. N.